

www.holyholds.at

the only way to heaven is up
never go down





Design Construct Develop

climbing area



*Kletterwände
nach Maß.*

Design Construct Develop

holycholds



*Klettergriffe
inspiriert von der Natur,
interpretiert durch
modernste Technik.*



The Spirit of Rock.

Als begeisterte Bergsteiger und Kletterer sind alle Mitarbeiter des DCD Teams bestrebt die Entwicklung des Klettersports bestmöglich zu fördern. In diesem Sinne resultieren unsere Produkte und Dienstleistungen aus einem innovativen Entwurfsprozess und widerspiegeln die Faszination Klettern.

Die Vorteile von DCD-Produkten:

- gewährleistete Sicherheit im Betrieb, dauerhafte Funktionalität und ökonomische Wartung.
- Innovation und fortlaufende Entwicklung sichert unseren Kunden langjährige Freude und Erfolg.

Größen/Farben/Empfehlung

limegreen
 limeyellow
 magenta
 rot
 dunkelblau
 hellblau
 violett
 orange
 grün
 gelb
 weiß
 grau
 schwarz



Hinweis: Die Größen sind nicht strikt von einander getrennt und können in einigen Fällen ident sein.



Platte



Wand



Überhang



Dach



Technik



Kraft



Kinder



Fixierung mit
Zylinderkopfschraube



Fixierung mit
Senkkopfschraube



Fixierung mit
Spaxschraube



Griffe

Griffset 50.1

50 Stück



limegreen
limeyellow
magenta
rot
dunkelblau
hellblau
violett
orange
grün
gelb
weiß
grau
schwarz

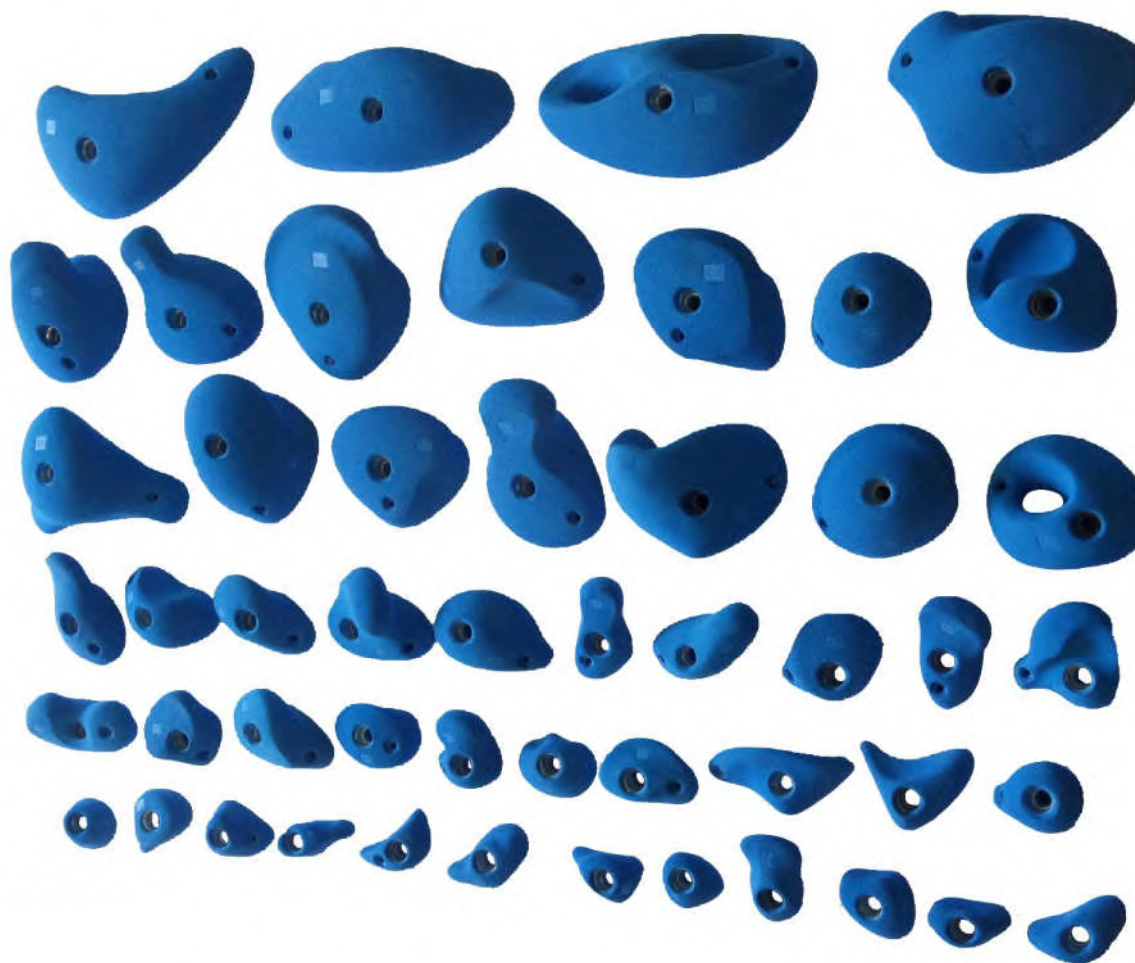

10 XS / 10 S / 10 M / 10 L / 10 XL

€ 349,99

Griffset 50.2



limegreen
limeyellow
magenta
rot
dunkelblau
hellblau
violett
orange
grün
gelb
weiß
grau
schwarz

10 XS / 10 S / 10 M / 10 L / 10 XL

50 Stück

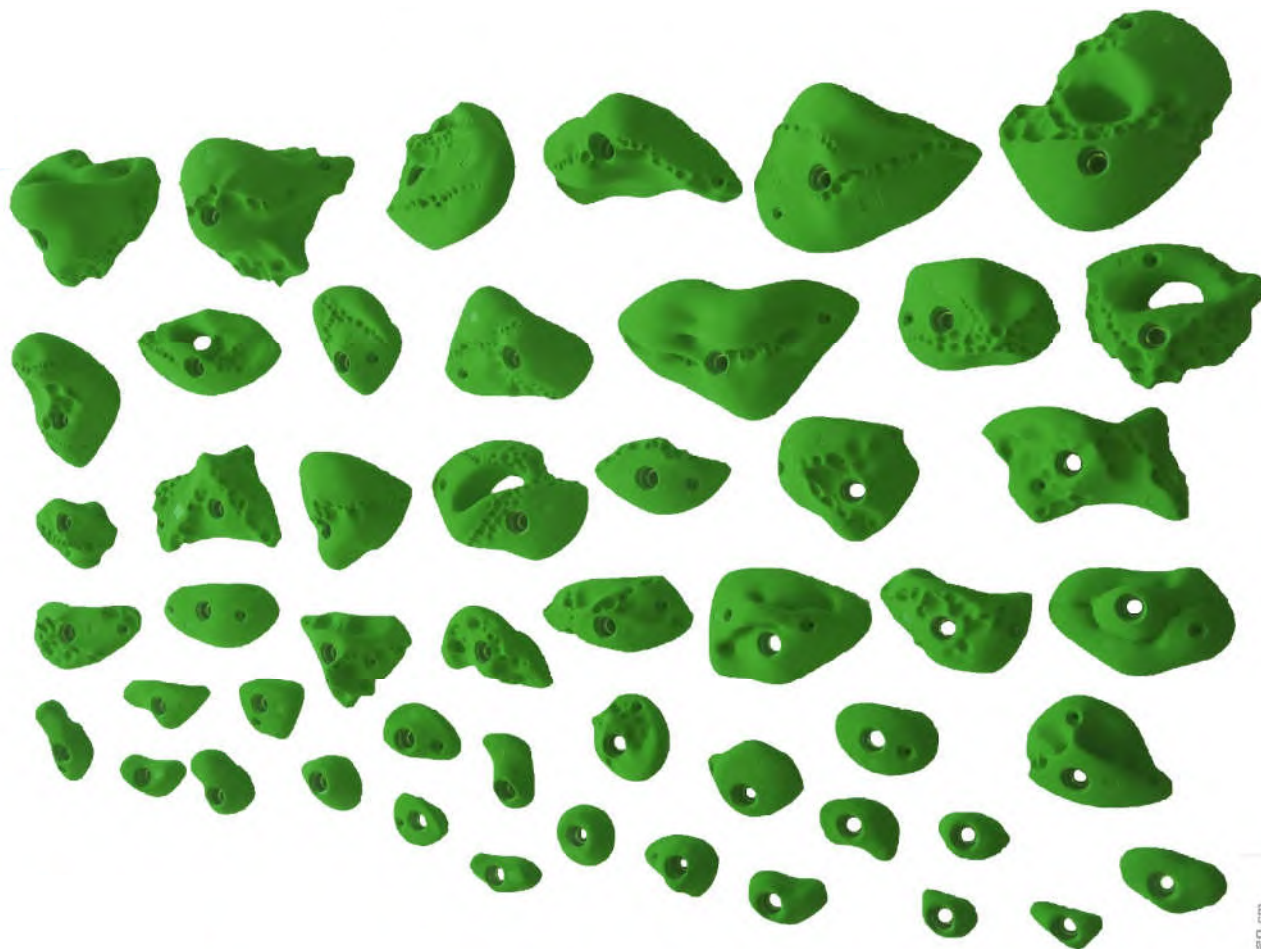

€ 349,99

Griffset 50.3

50 Stück



limegreen
limeyellow
magenta
rot
dunkelblau
hellblau
violett
orange
grün
gelb
weiß
grau
schwarz



10 XS / 10 S / 10 M / 10 L / 10 XL

€ 349,99

Griffset 50.4



limegreen
limeyellow
magenta
rot
dunkelblau
hellblau
violett
orange
grün
gelb
weiß
grau
schwarz

10 XS / 10 S / 10 M / 10 L / 10 XL

50 Stück

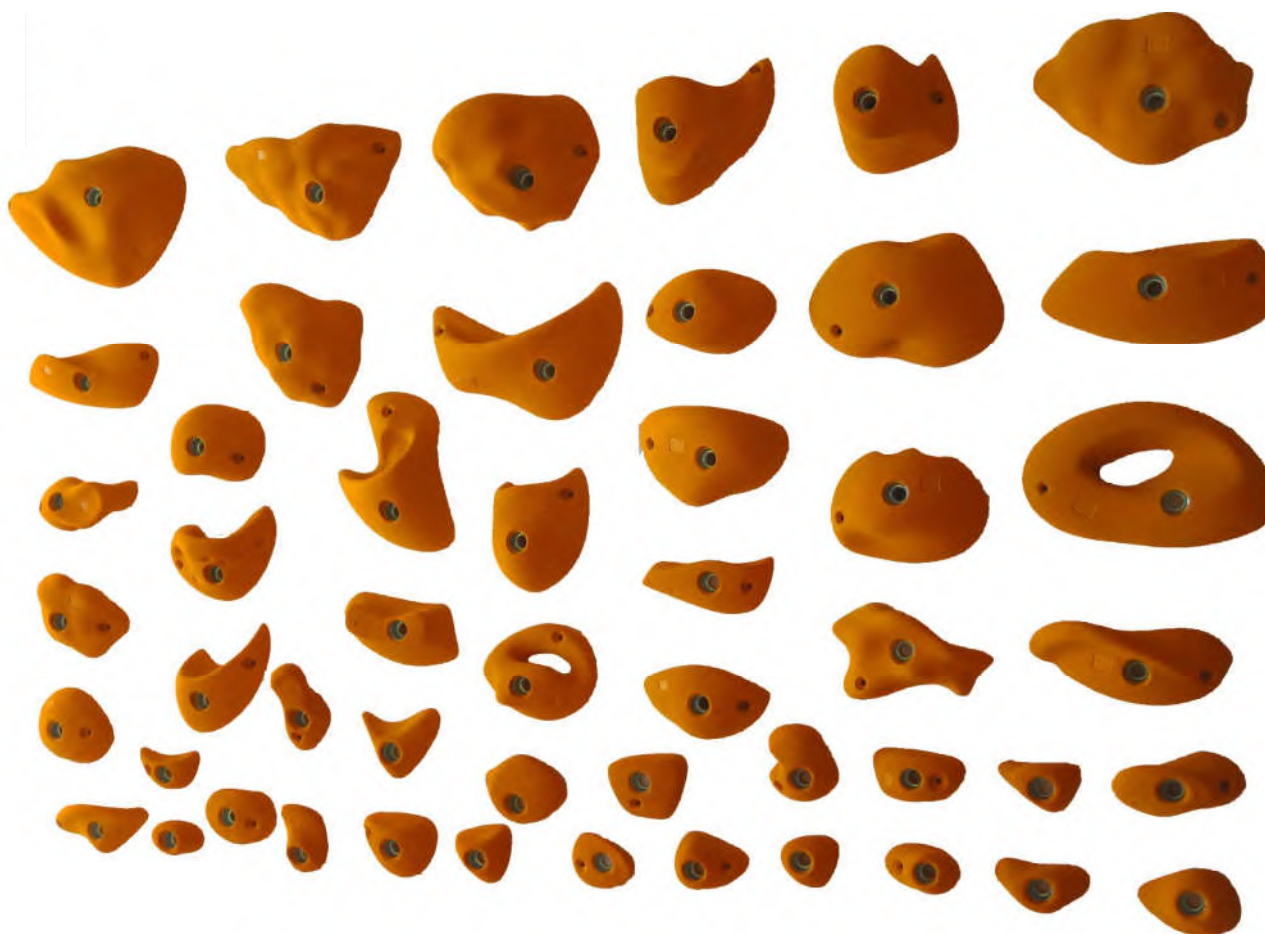

€ 349,99

Griffset 50.5

50 Stück



limegreen
limeyellow
magenta
rot
dunkelblau
hellblau
violett
orange
grün
gelb
weiß
grau
schwarz



10 XS / 10 S / 10 M / 10 L / 10 XL

€ 349,99

Griffset 50.6



limegreen
limeyellow
magenta
rot
dunkelblau
hellblau
violett
orange
grün
gelb
weiß
grau
schwarz

10 XS / 10 S / 10 M / 10 L / 10 XL

50 Stück

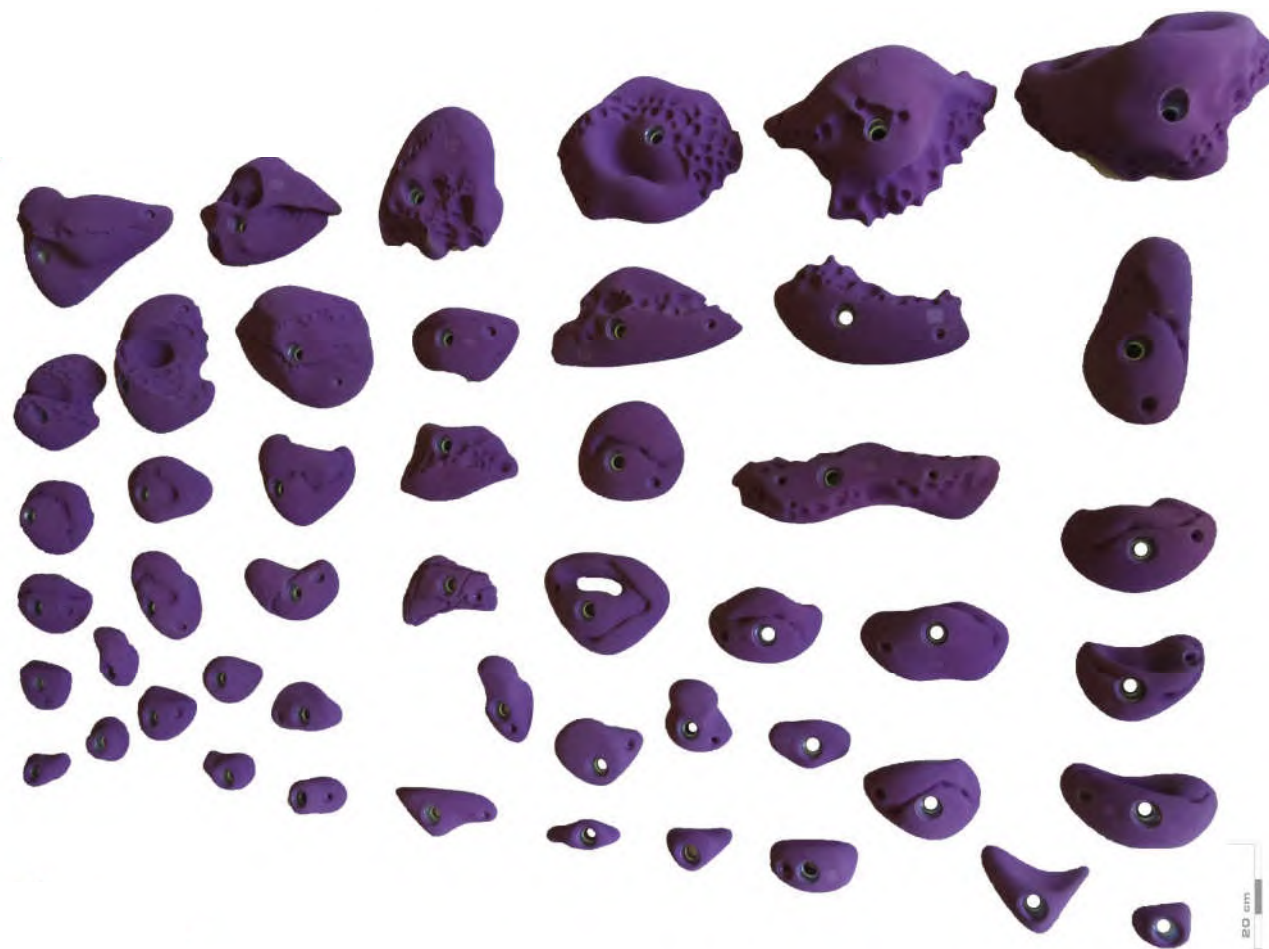

€ 349,99

Griffset Kalkstein



limegreen
limeyellow
magenta
rot
dunkelblau
hellblau
violett
orange
grün
gelb
weiß
grau
schwarz

5 S / 10 M / 10 L / 10 XL / 5 XXL

40 Stück



€ 349,99

Griffset Sandstein



limegreen
limeyellow
magenta
rot
dunkelblau
hellblau
violett
orange
grün
gelb
weiß
grau
schwarz

5 S / 10 M / 10 L / 10 XL / 5 XXL

40 Stück



€ 349,99

Griffset Granit



limegreen
limeyellow
magenta
rot
dunkelblau
hellblau
violett
orange
grün
gelb
weiß
grau
schwarz



40 Stück



5 S / 10 M / 10 L / 10 XL / 5 XXL

€ 349,99

Griffset Granitbeißer



limegreen
limeyellow
magenta
rot
dunkelblau
hellblau
violett
orange
grün
gelb
weiß
grau
schwarz

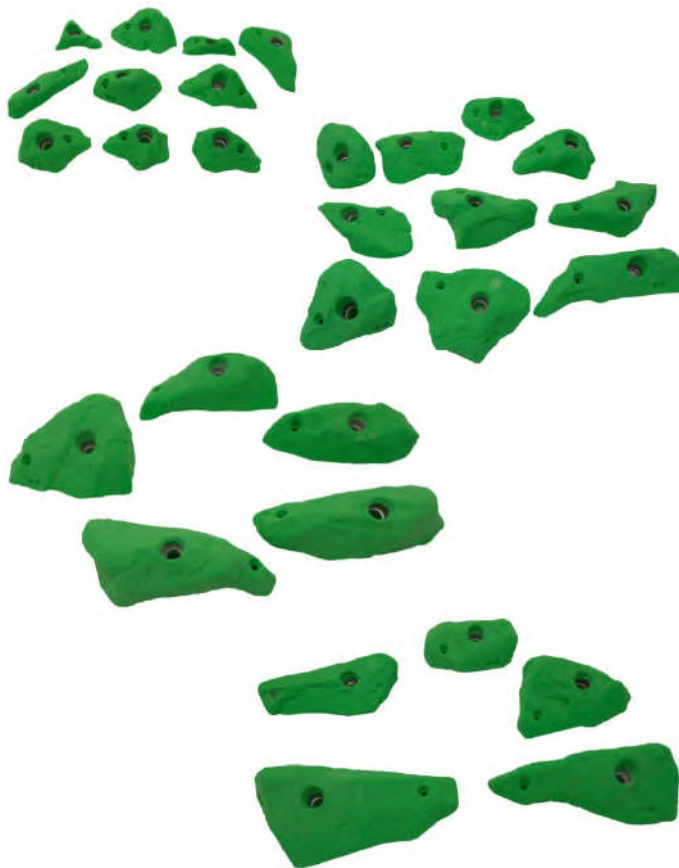

50 Stück

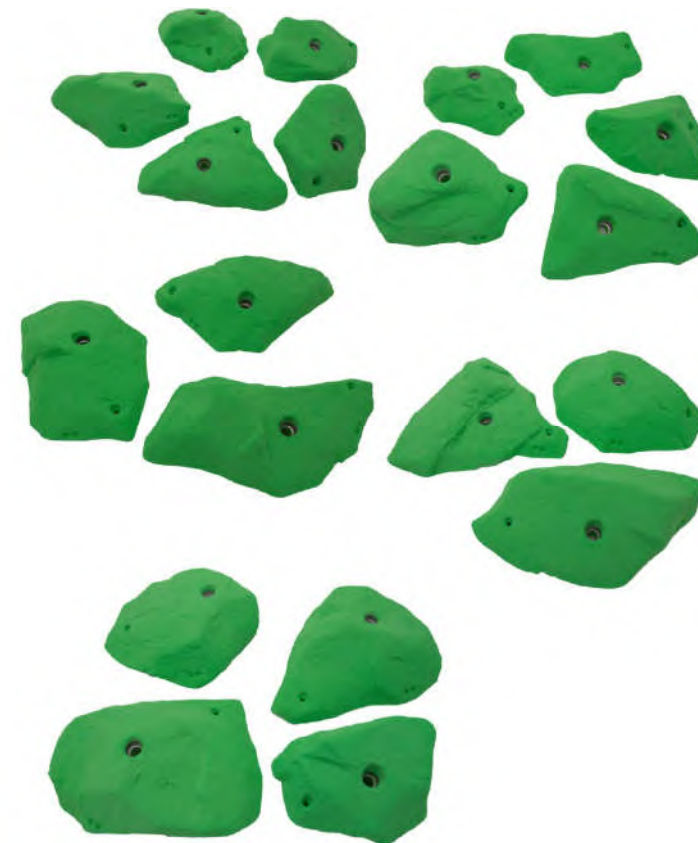

10 M / 20 L / 10 XL / 10 XXL

€ 474,99

Griffset fontainebleau



limegreen
limeyellow
magenta
rot
dunkelblau
hellblau
violett
orange
grün
gelb
weiß
grau
schwarz

5 S / 10 M / 10 L / 10 XL / 5 XXL

40 Stück

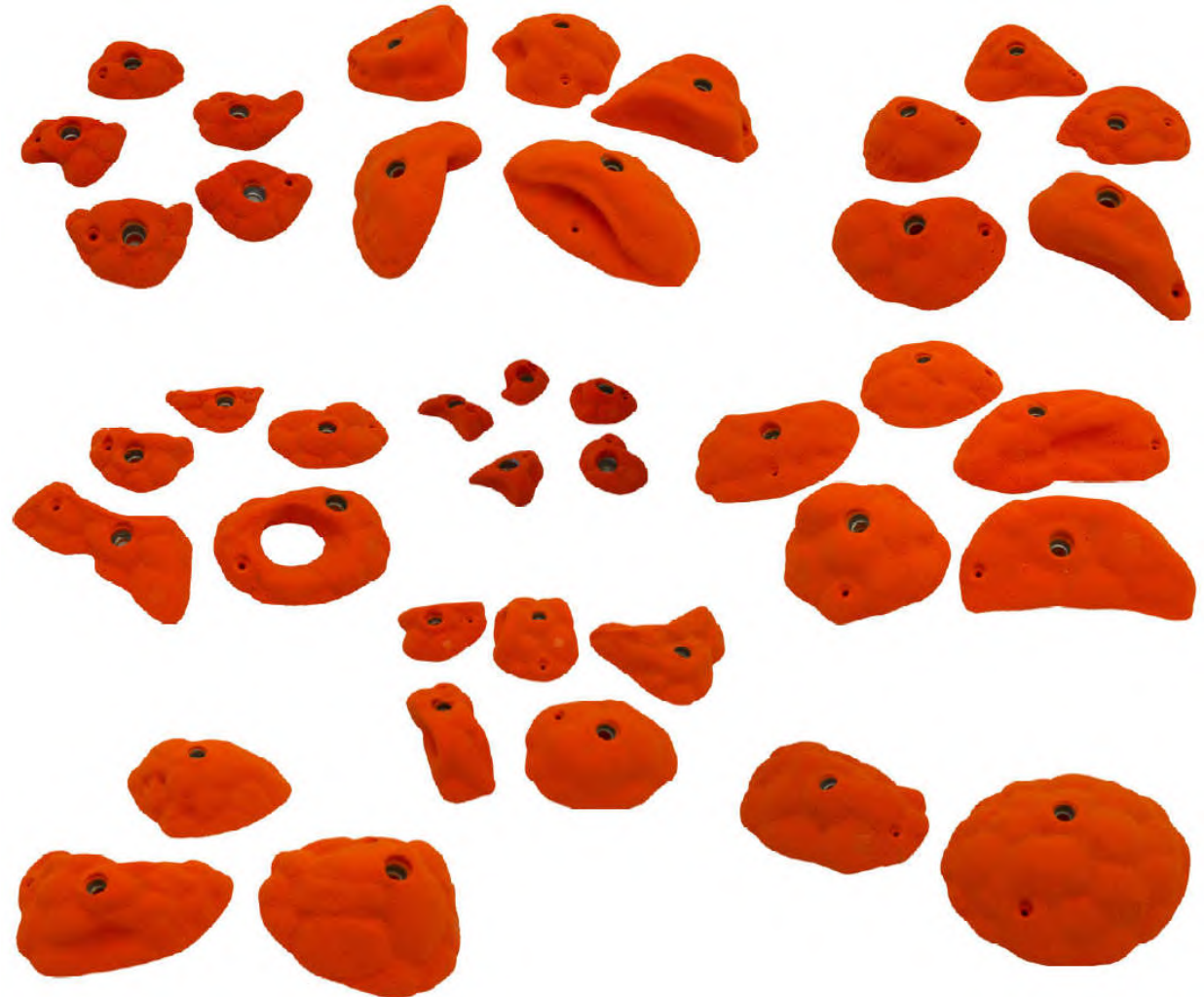

€ 358,33

Griffset XS & small

20 Stück



limegreen
limeyellow
magenta
rot
dunkelblau
hellblau
violett
orange
grün
gelb
weiß
grau
schwarz

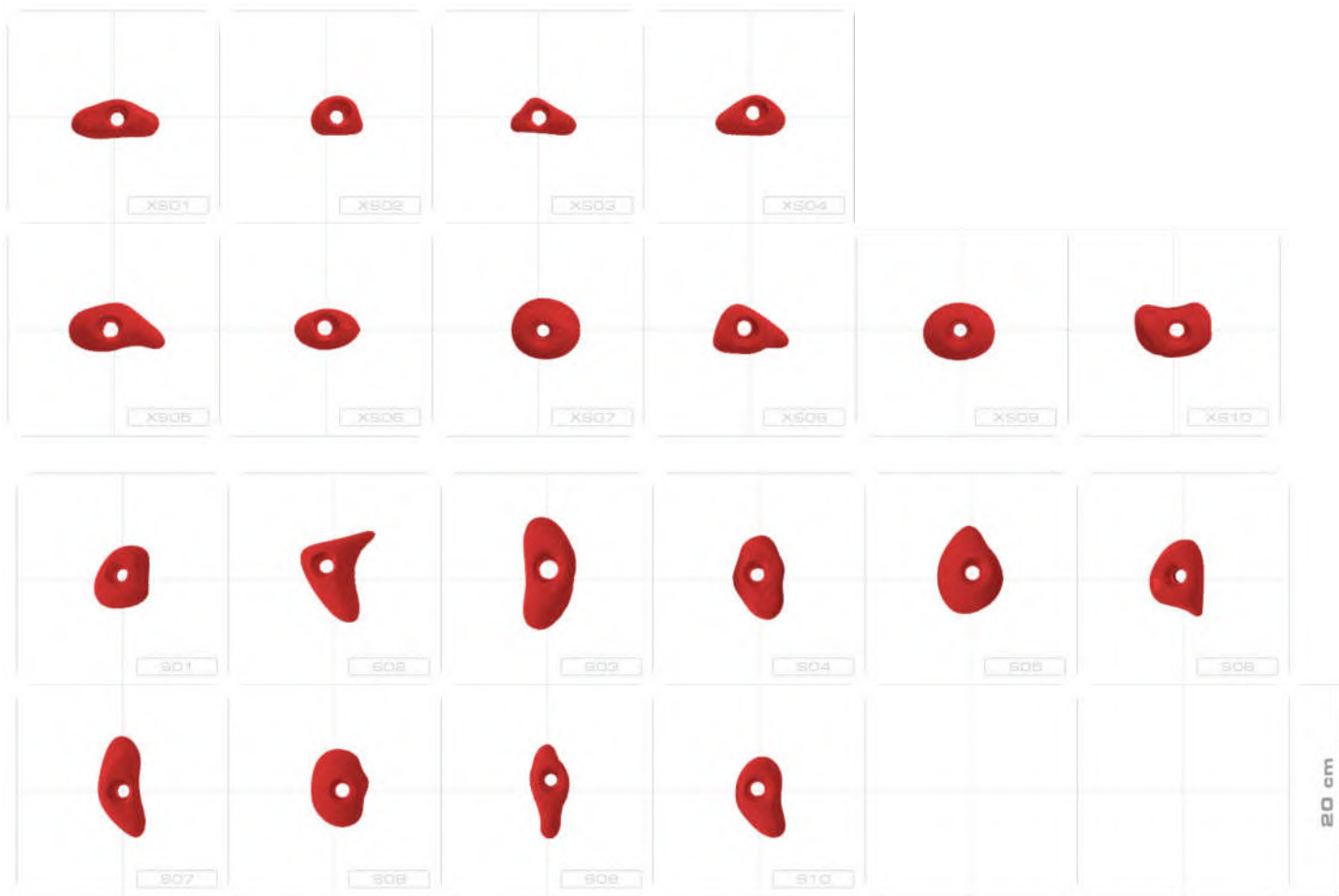

10 XS / 10 S

€ 65,75

Griffset Kinder



limegreen
limeyellow
magenta
rot
dunkelblau
hellblau
violett
orange
grün
gelb
weiß
grau
schwarz



30 Stück

10 Tiere XXL / 10 Buchstaben XL / 10 Zahlen L

€ 299,99

Griffset JC I



limegreen
limeyellow
magenta
rot
dunkelblau
hellblau
violett
orange
grün
gelb
weiß
grau
schwarz

5 M / 5 L / 10 XL / 5 XXL

25 Stück

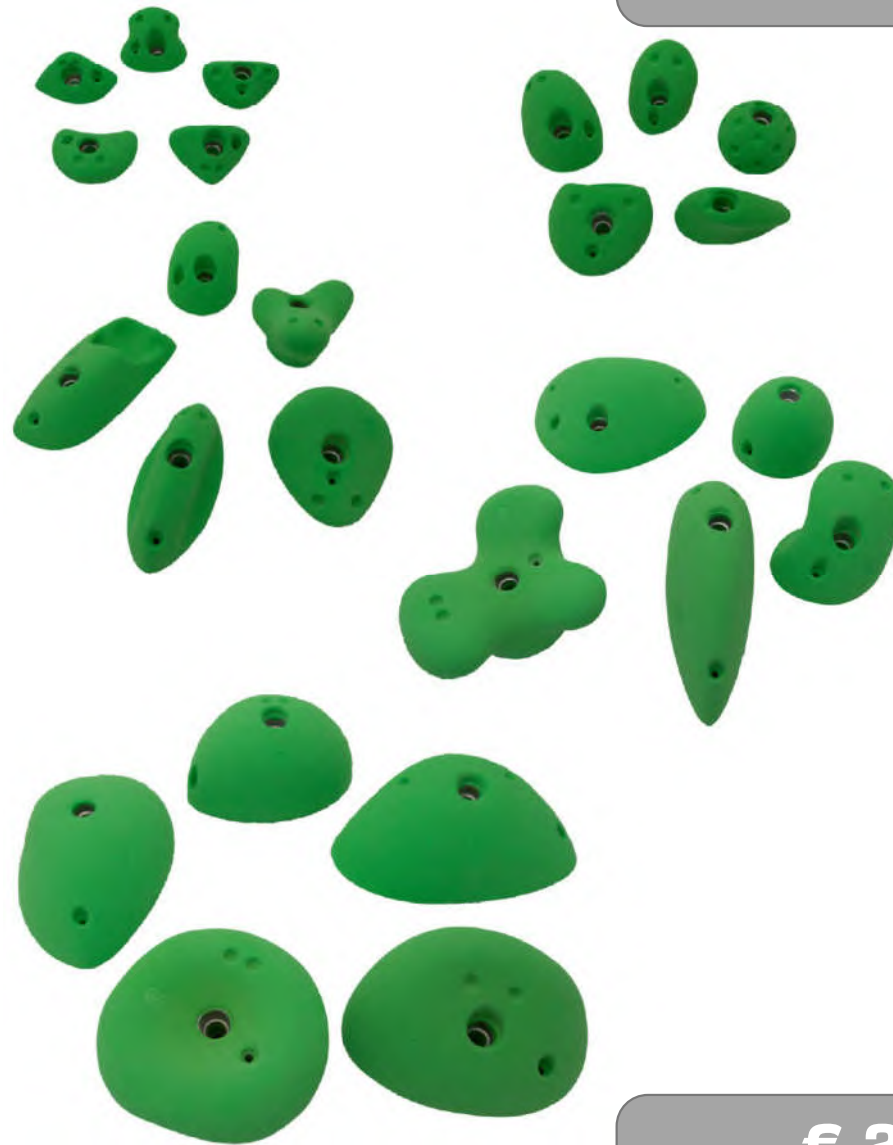

€ 249,99

Griffset JC II



limegreen
limeyellow
magenta
rot
dunkelblau
hellblau
violett
orange
grün
gelb
weiß
grau
schwarz

5 M / 5 L / 10 XL / 5 XXL

25 Stück

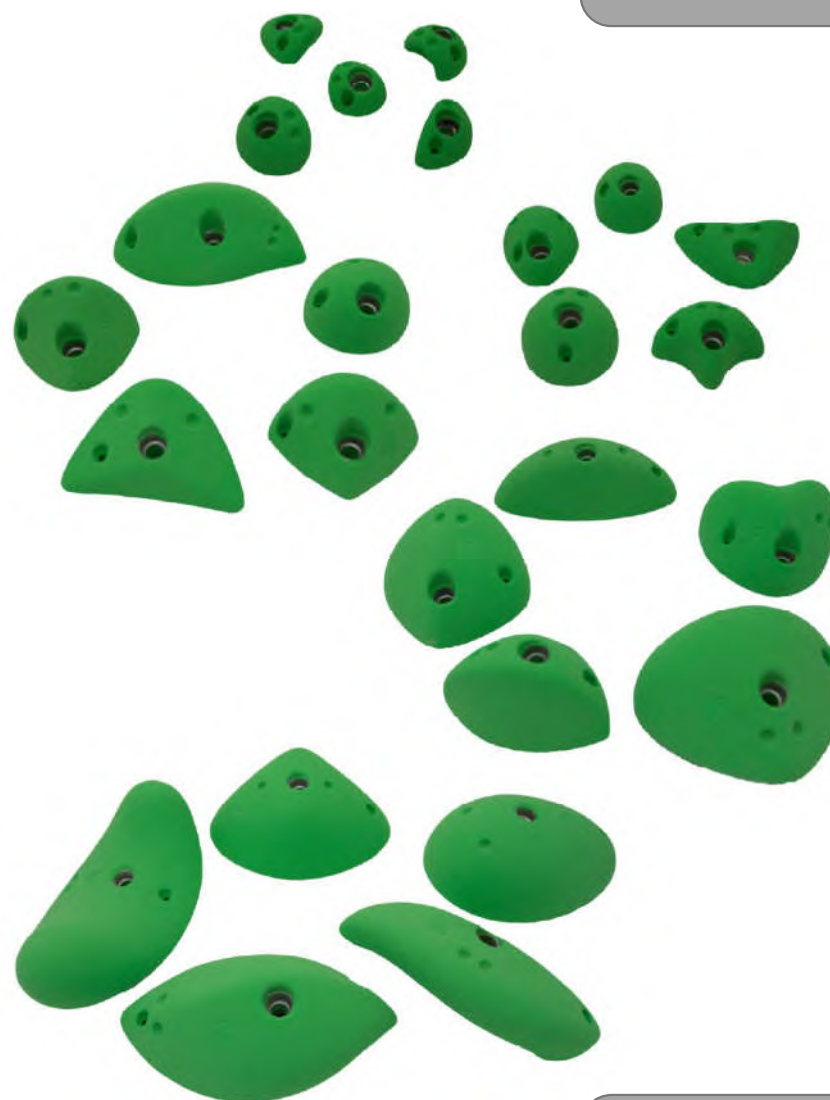

€ 249,99

Griffset JC 100



limegreen
limeyellow
magenta
rot
dunkelblau
hellblau
violett
orange
grün
gelb
weiß
grau
schwarz



100 Stück



18 S / 25 M / 30 L / 15 XL / 12 XXL

€ 749,99

Griffset roof I



limegreen
limeyellow
magenta
rot
dunkelblau
hellblau
violett
orange
grün
gelb
weiß
grau
schwarz

5 XXL

5 Stück



€ 83,33

Griffset roof II



limegreen
limeyellow
magenta
rot
dunkelblau
hellblau
violett
orange
grün
gelb
weiß
grau
schwarz

5 XXL

5 Stück



€ 83,33

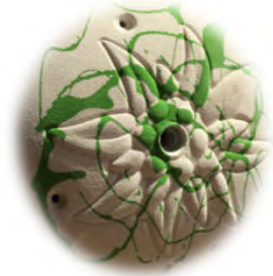

SpezialGriffe

Routenbeschriftung

XXL

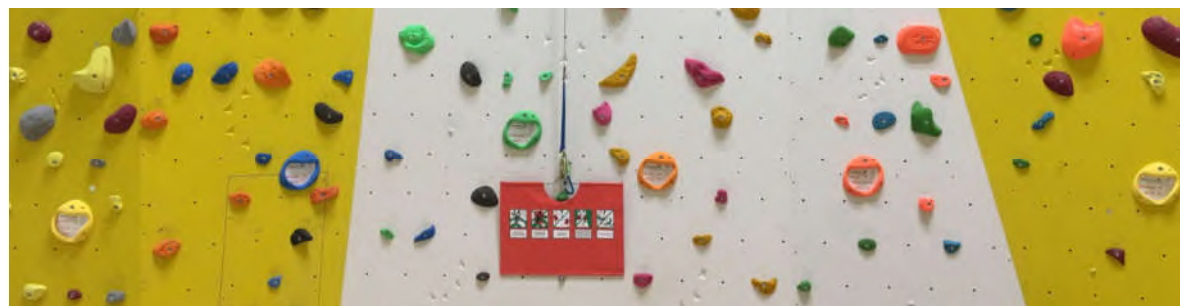

Beschriftungsfeld

€ 12,42

Logogriffe

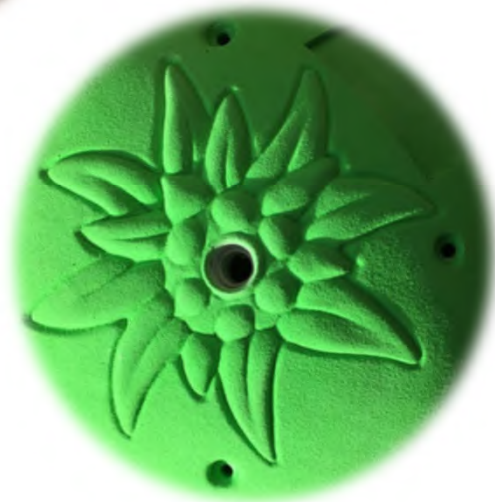
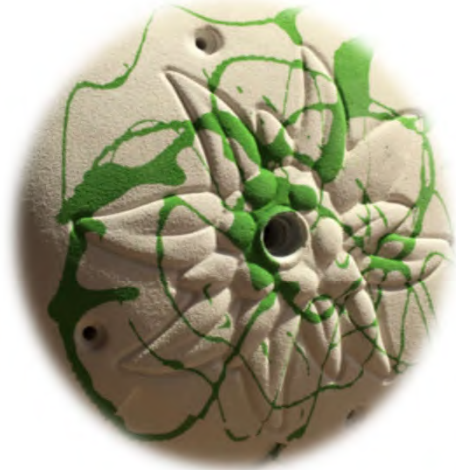

alle Größen



nach Wunsch

Preis auf Anfrage

Schraubensets



nach Wunsch

Sechskant Stiftschlüssel



€ 16,58

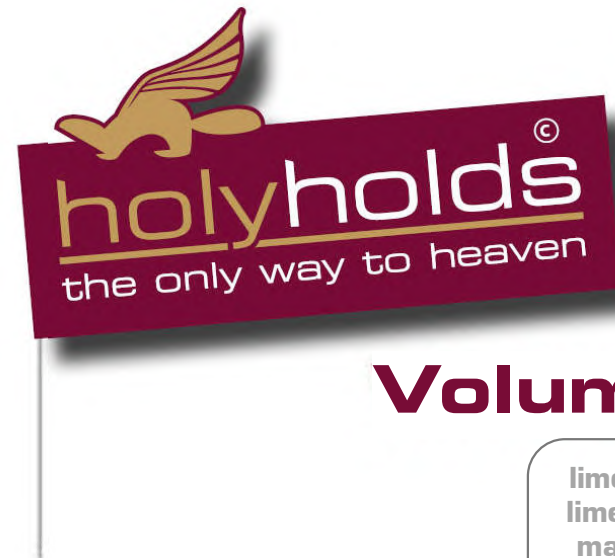

Volumen

limegreen
limeyellow
magenta
neonorange
red
orange
yellow
blue
violett
white
black

Volumen V01 – V04

Raster 100mm

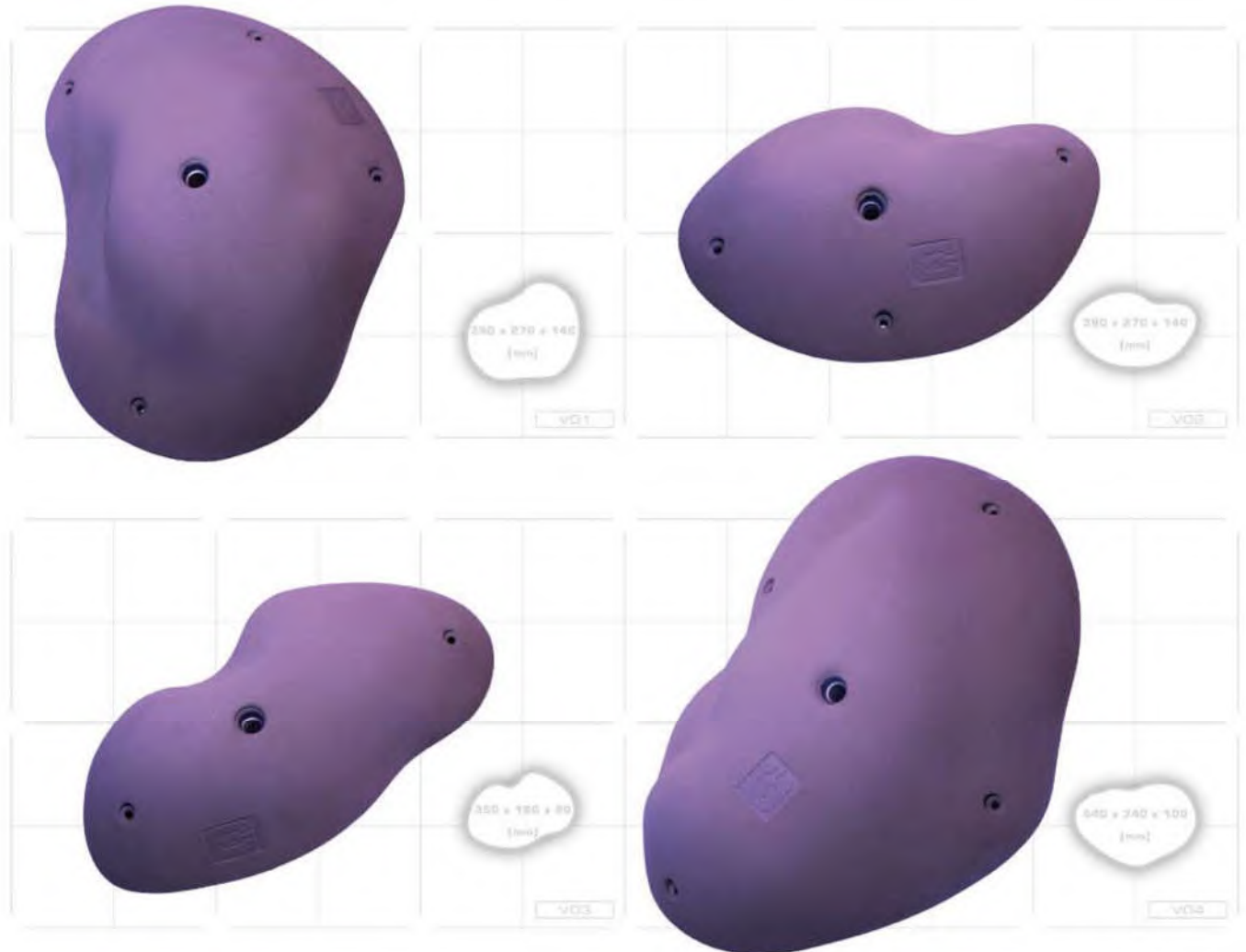

large

€ 49,90 je Stück

Volumen V05 - V08

Raster 100mm

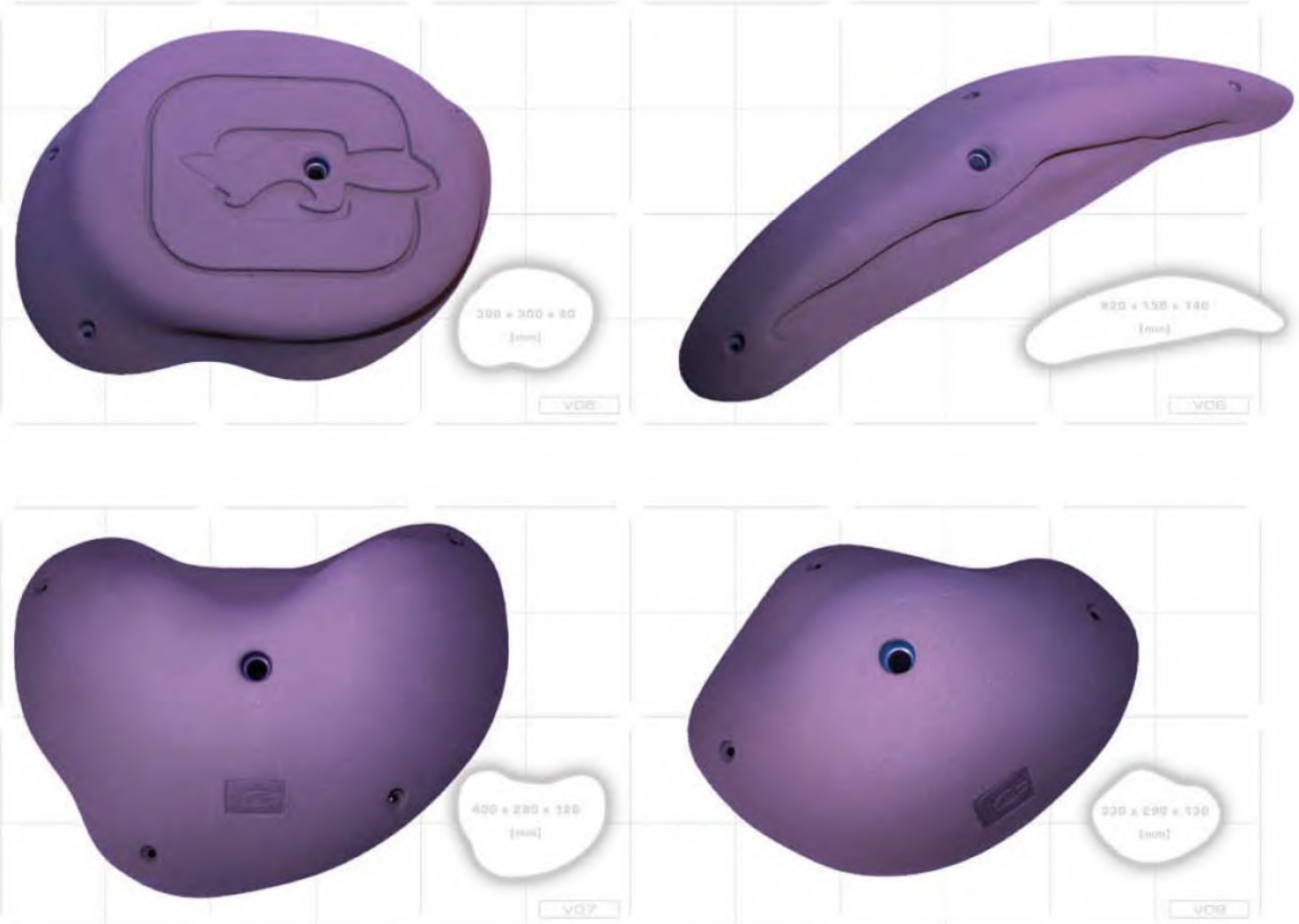

large

€ 49,90 je Stück

Volumen Set S

5 Stück



small

€ 187,40

Volumen Set M

7 Stück

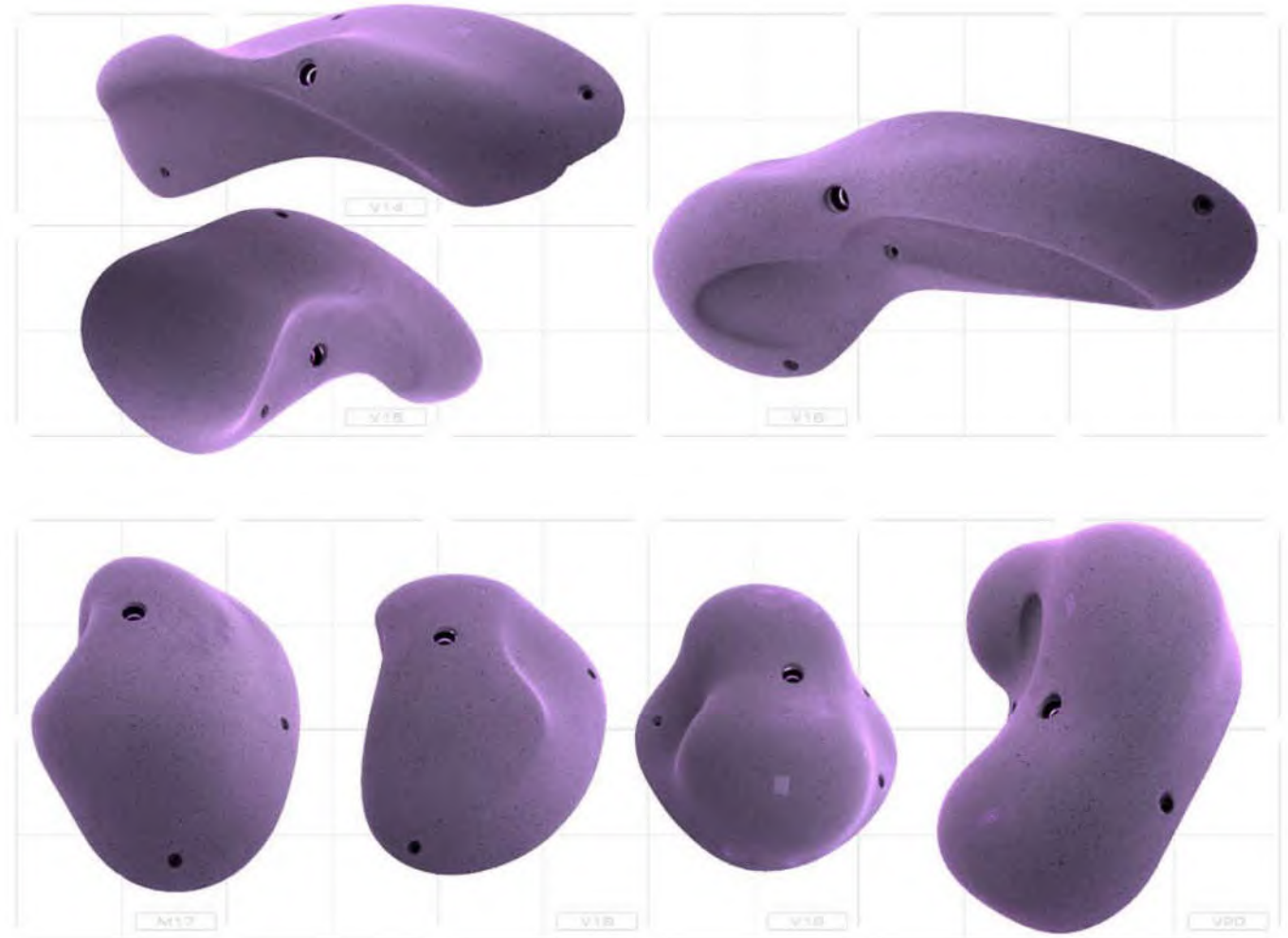

medium

€ 324,90

Volumen Set L

3 Stück

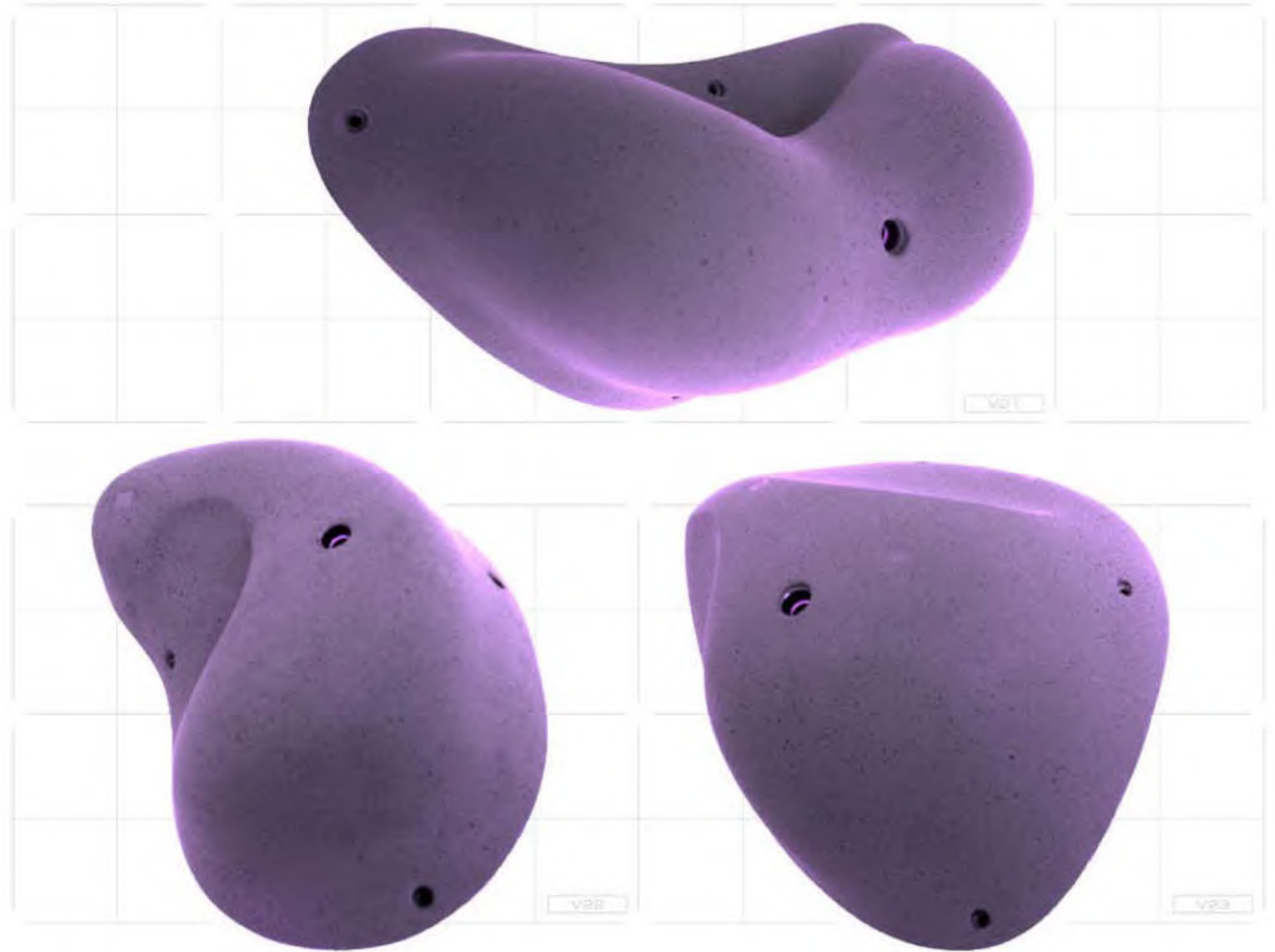

large

€ 174,90

Volumen A small



€ 41,60



1950g / 315x230x110mm

Volumen B small



€ 41,60



1815g / 250x220x120mm

Volumen C small



€ 41,60



2165g / 370x260x65mm

Volumen D small



€ 41,60



1505g / 280x230x105mm

Volumen E small



€ 41,60



1815g / 280x230x100mm

Volumen F medium



€ 49,90



2270g / 345x230x110mm

Volumen G medium



€ 49,90



2875g / 295x260x135mm

Volumen H medium



€ 49,90

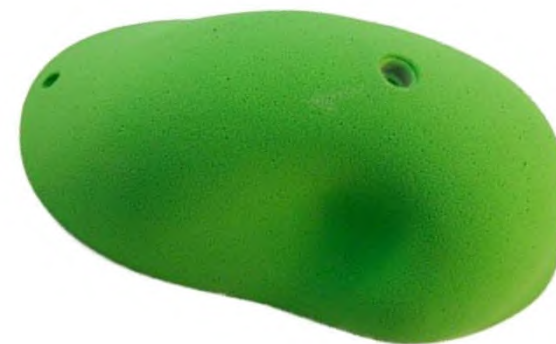

2670g / 360x240x140mm

Volumen I medium



€ 49,90



3085g / 385x260x140mm

Volumen J medium



€ 49,90



3365g / 575x195x130mm

Volumen K medium



€ 49,90



2400g / 525x260x95mm

Volumen L medium



€ 49,90



2350g / 480x215x95mm

Volumen M large



€ 62,40



4040g / 495x245x185mm

Volumen N large



€ 62,40



2890g / 445x270x130mm

Volumen G01 large



€ 62,40

4620g / 740x285x150mm

Volumen G02 medium



€ 49,90

3660g / 420x170x190mm

Volumen G03 large



€ 62,40

4270g / 345x480x100mm

Volumen G04 large



€ 62,40

3610g / 355x605x120mm

Volumen G05 large



€ 62,40

4530g / 370x435x130mm

Volumen G06 medium



€ 49,90

3125g / 380x290x115mm

Volumen G07 medium



€ 49,90

3360g / 295x380x145mm

Volumen G08 large



€ 62,40

3330g / 450x230x150mm

Volumen G09 medium



€ 49,90



3090g / 250x425x115mm

Volumen G10 medium



€ 49,90



3545g / 420x335x65mm

Volumen G35 large



€ 62,40



4450g / 405x325x215mm

Volumen G36 large



€ 62,40



3940g / 745x265x60mm

Volumen G37 large



€ 62,40

4190g / 255x770x105mm

Volumen G38 medium



€ 49,90

2290g / 445x185x130mm

Volumen G40 large



€ 62,40



4925g / 320x435x140mm

Volumen G41 large



€ 62,40



3260g / 355x315x150mm

Volumen G42 medium



€ 49,90

3160g / 405x325x120mm

Volumen G43 large



€ 62,40

4265g / 315x425x185mm

Volumen G44 medium



€ 49,90



4170g / 235x475x165mm

Volumen G45 large



€ 62,40



3020g / 470x265x120mm

Volumen G46 medium



€ 49,90



2545g / 375x300x80mm

Volumen G47 medium



€ 49,90



2480g / 395x280x60mm

Volumen G48 medium

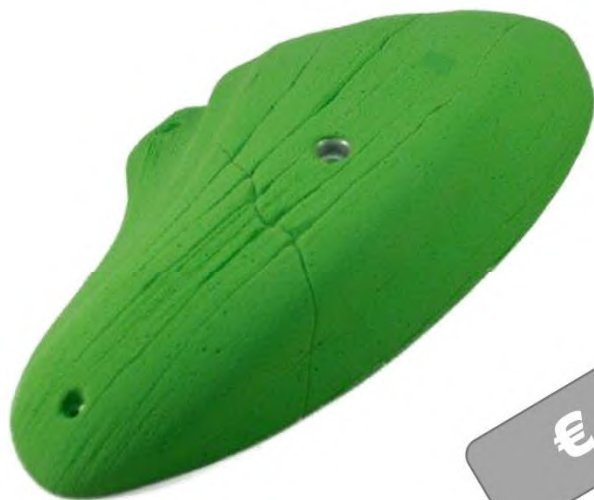

€ 49,90



2330g / 455x255x85mm

Volumen G49 medium



€ 49,90



2925g / 425x220x120mm

Volumen G50 medium



€ 49,90



3150g / 405x240x130mm

Volumen G51 large



€ 62,40



3400g / 300x285x150mm

Volumen G52 large



€ 62,40



4030g / 410x295x150mm

Volumen G53 large



€ 62,40



4175g / 415x270x195mm

Volumen G54 large

€ 62,40



4880g / 730x200x110mm

Volumen G55 large

€ 62,40



3150g / 645x170x110mm

Volumen G54+55



4880g / 730x200x110mm

2 X large



3150g / 645x170x110mm

€ 116,58

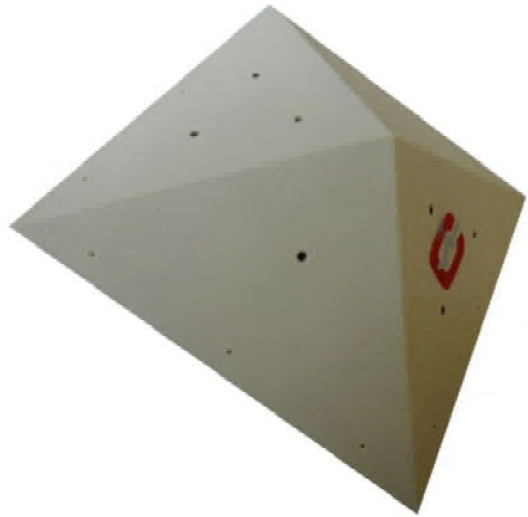

Strukturen Holz

RAL 1015 hellelfenbein
andere Farben auf Anfrage

Struktur A

600x600x250mm

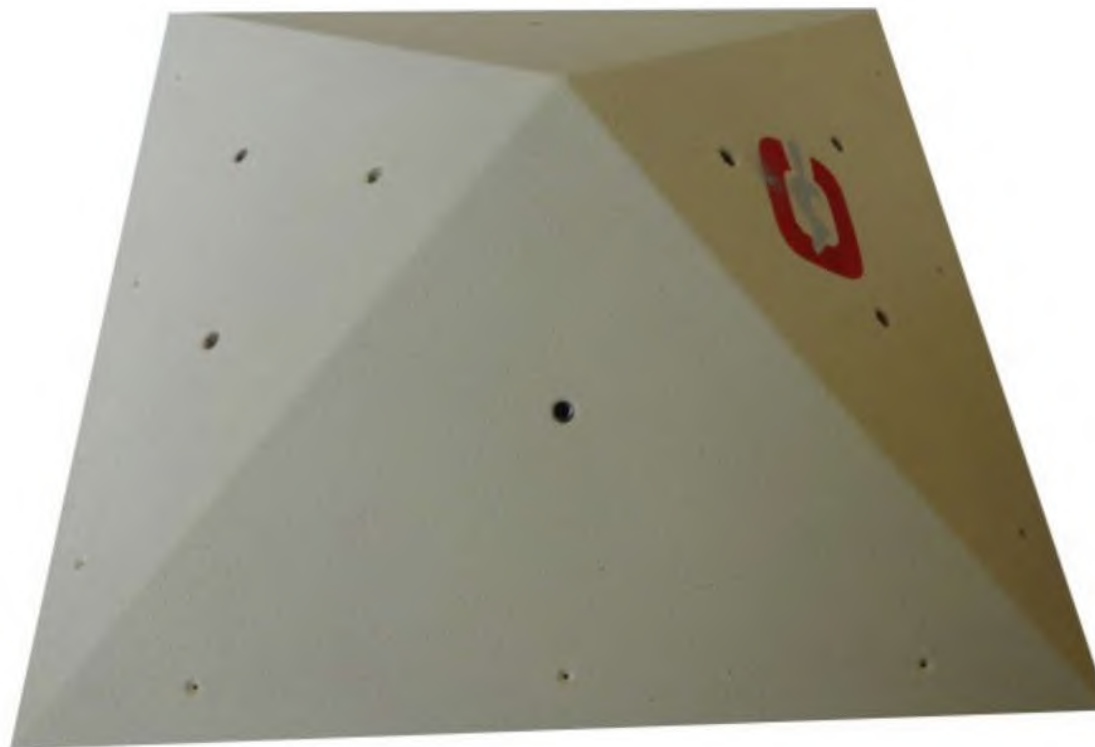
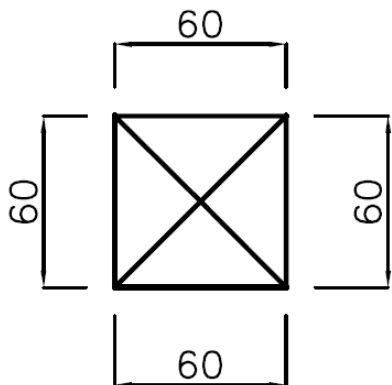

5200g Raster 15/15

€ 124,17

Struktur B

600x600x180mm

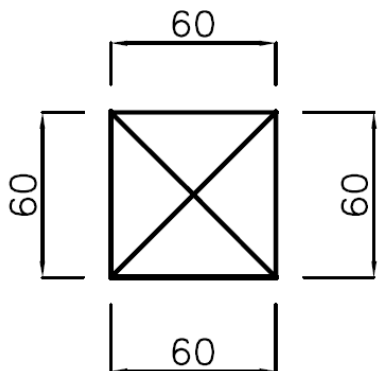

5200g Raster 15/15

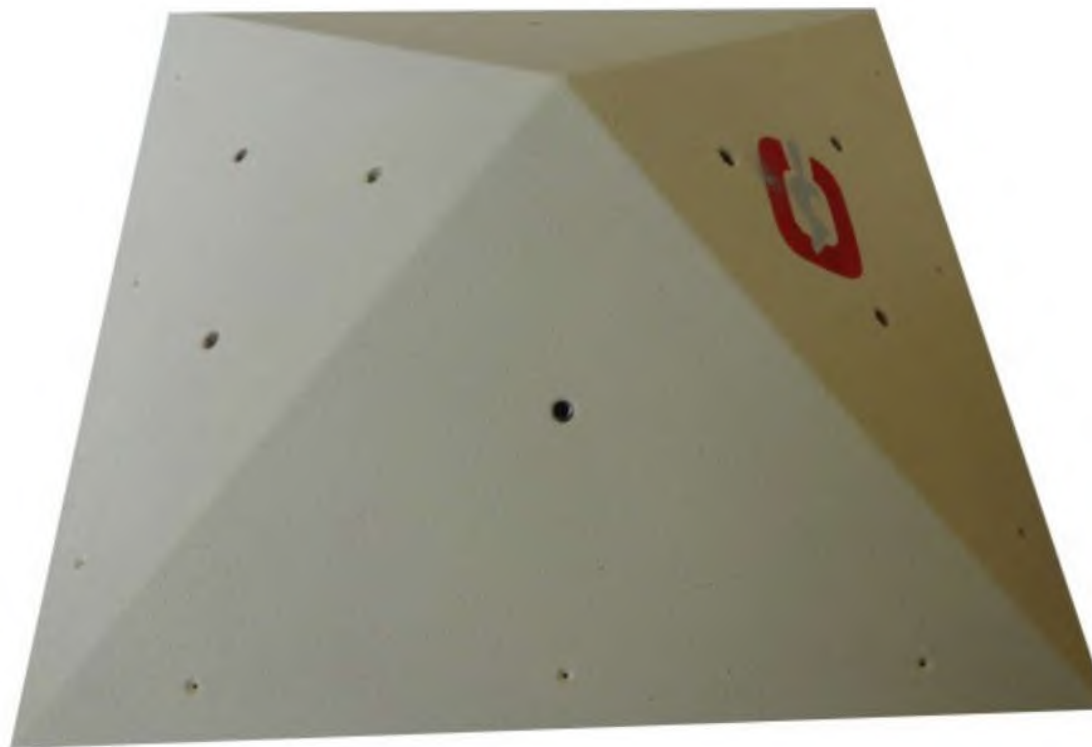

€ 124,17

Struktur C

1000x360x134mm

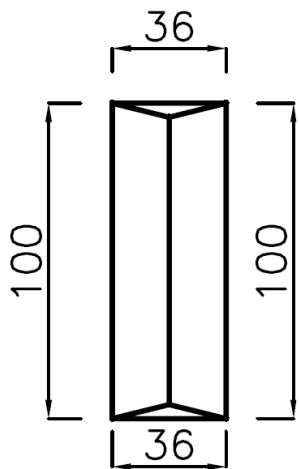

5880g Raster 15/15

€ 124,17

Struktur D

(671)x436x201mm

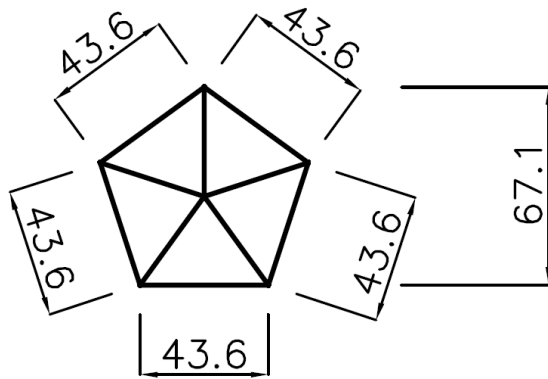

5300g Raster 15/15

€ 124,17

Struktur E

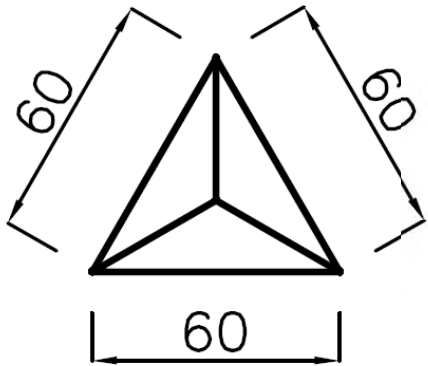

600x600x175mm



5290g Raster 15/15

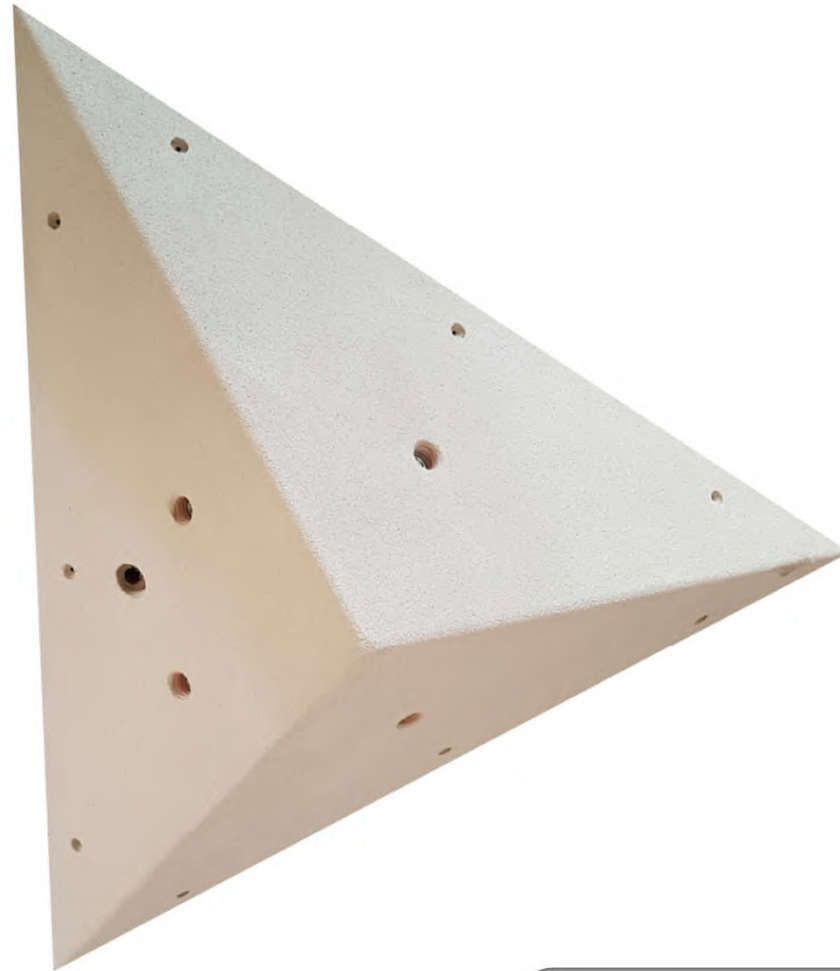

€ 95,75

Struktur F

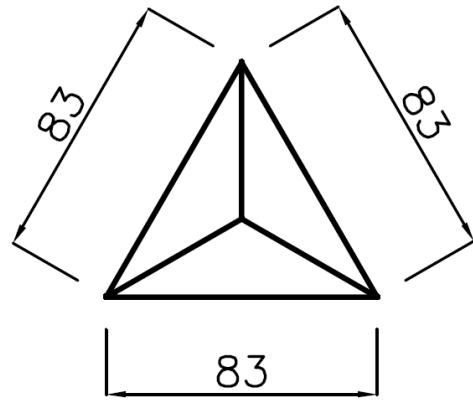

6250g Raster 15/15

830x830x240mm

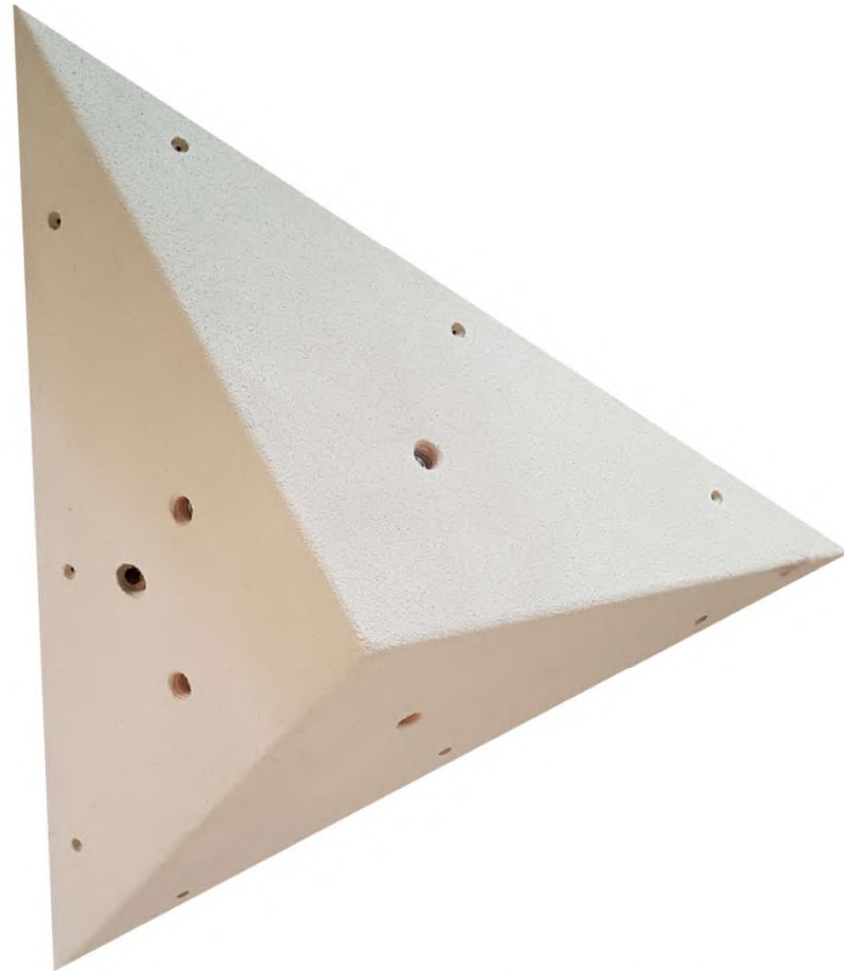

€ 112,42

Struktur G

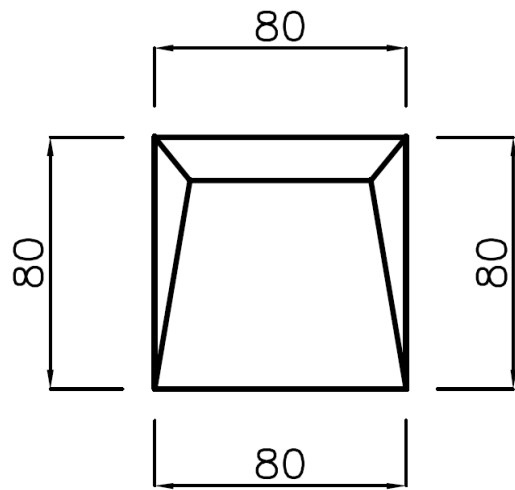

9450g Raster 15/15

800x800x266mm



€ 116,58

Struktur H

1000x600x190mm

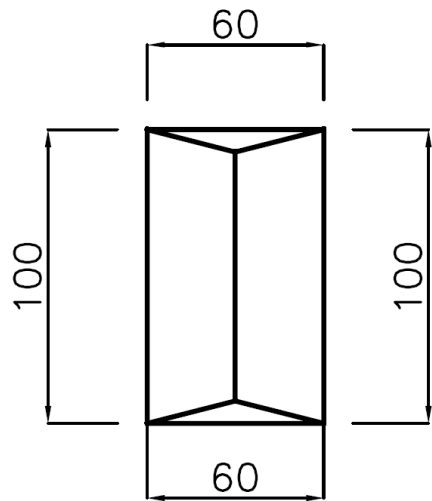

8900g Raster 15/15

€ 116,58

Struktur I

800x800x330mm

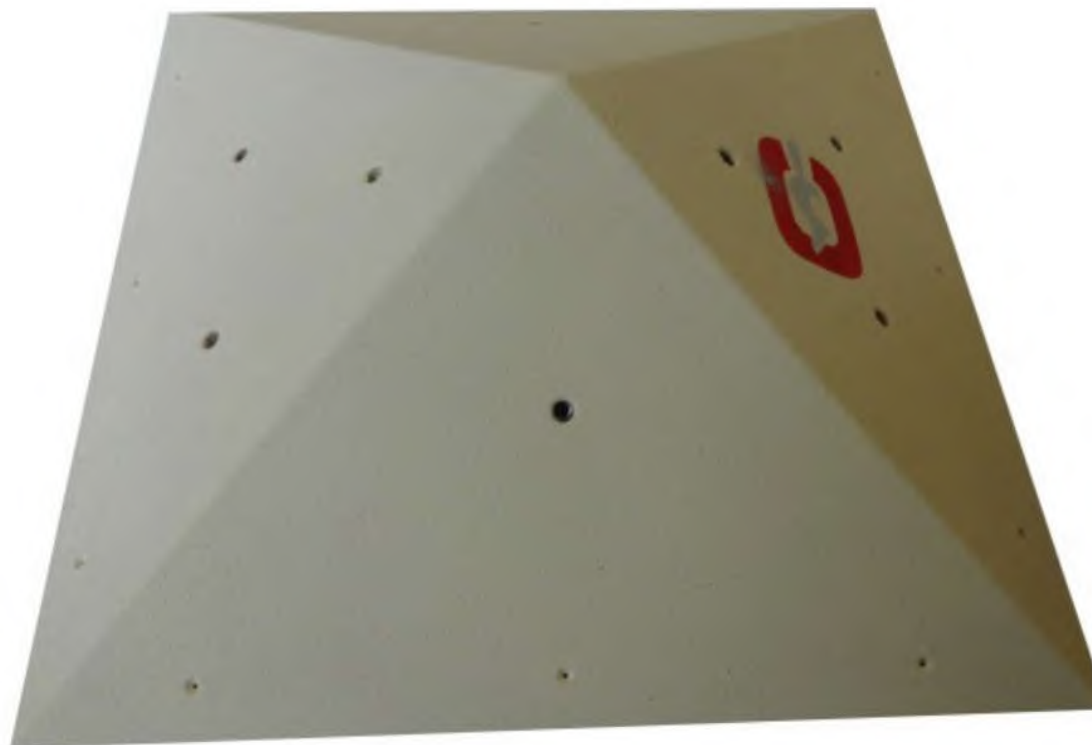
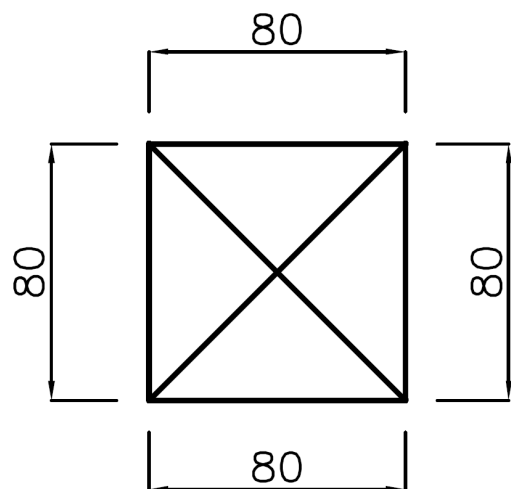

9400g Raster 15/15

€ 133,25

Struktur J

800x800x240mm

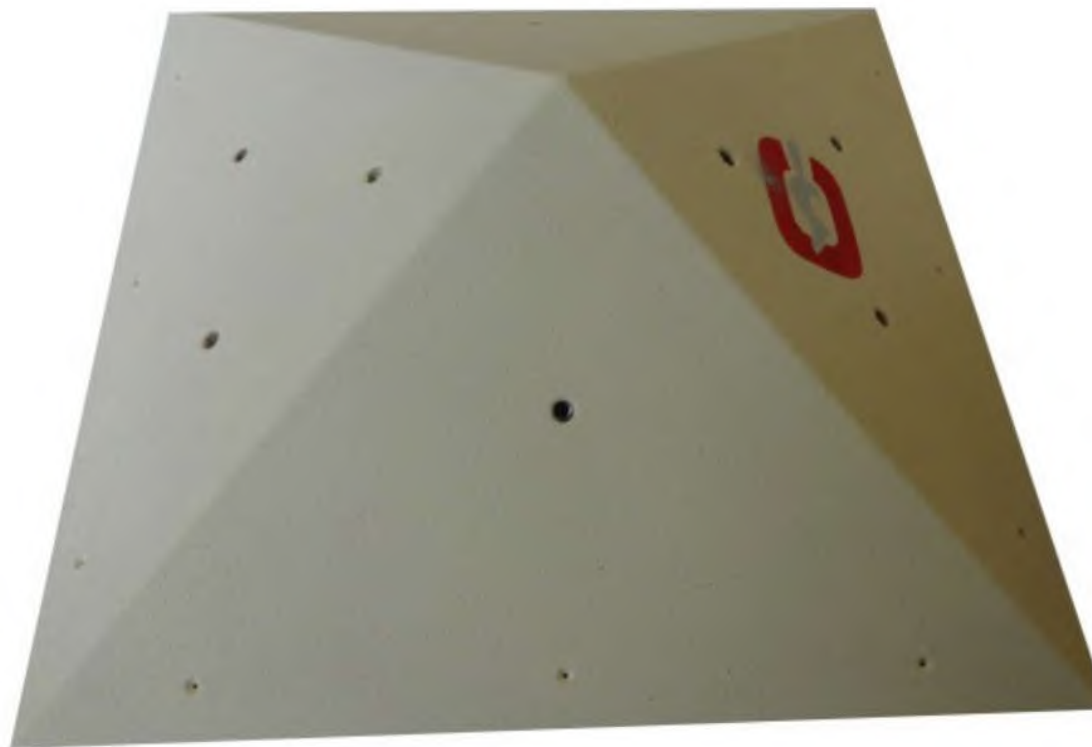
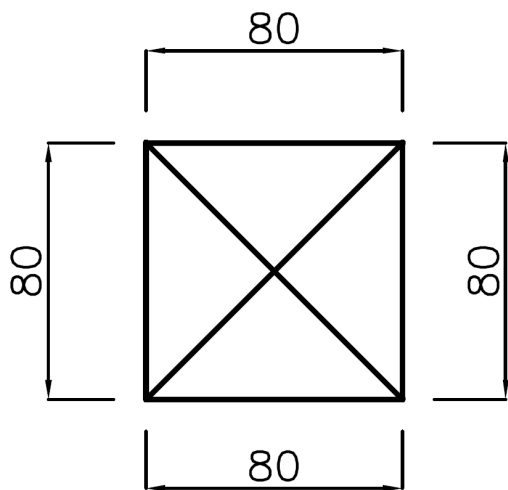

9300g Raster 15/15

€ 133,25

Struktur K

(894)x581x350mm

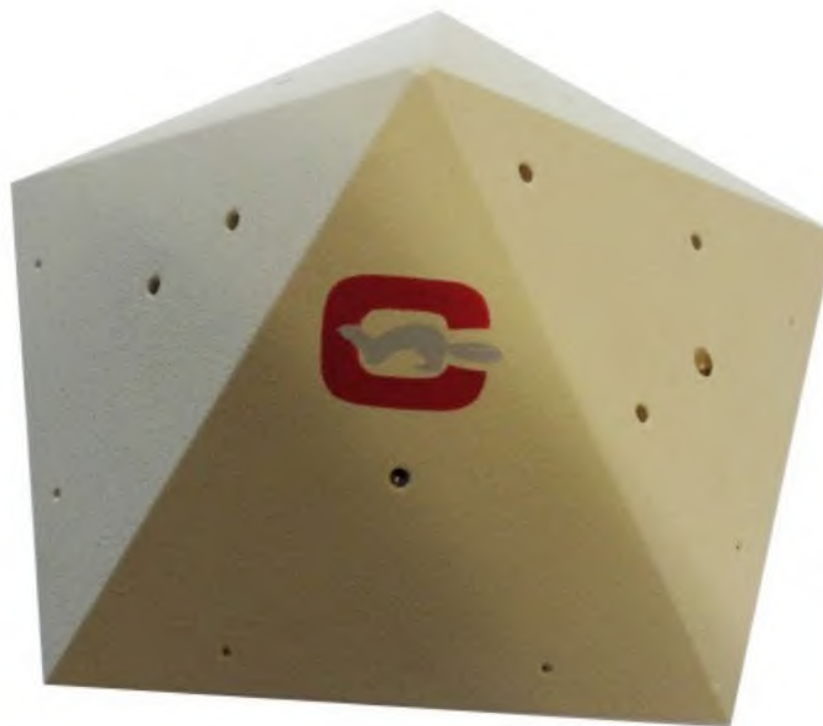
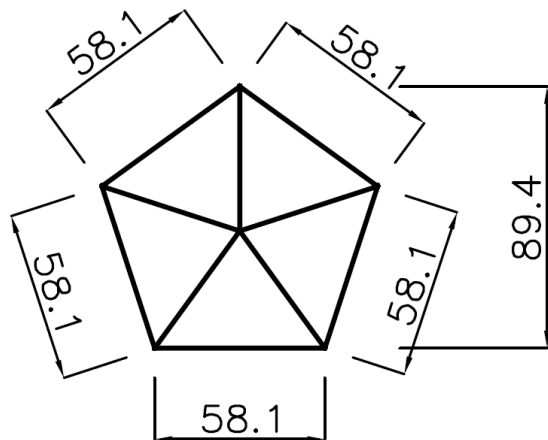

8900g Raster 15/15

€ 141,58



**Strukturen
GFK**

Struktur 1 dumbbell

900x210x160mm



limegreen
limeyellow
magenta
neonorange
red
orange
yellow
blue
violett
white
black

8 Griffbefestigungen

€ 141,58

Struktur 2 halbdome

500x450x310mm



limegreen
limeyellow
magenta
neonorange
red
orange
yellow
blue
violett
white
black

8 Griffbefestigungen

€ 158,25

Technik & Sicherheit

holycholds werden aus hochwertigem ultraleichtem Polyesterharz nach Wunsch auch mit Faserbewehrung (unbreakabel) oder auch UV beständig hergestellt. hollyholds erfüllen alle Vorgaben der DIN EN 12572-3. Künstliche Kletteranlagen - Teil 3: Sicherheitstechnische Anforderungen und Prüfverfahren für Klettergriffe. Geprüfte Sicherheit bestätigt durch den TÜV Österreich.

Um die Norm (Punkt 4.6 - Schutz der Oberfläche der künstlichen Kletteranlage) zu erfüllen muss bei ausgewählten Griffen auch die Spaxbohrung als Befestigungsmöglichkeit verwendet werden.

Anzugsdrehmomente

Die angeführten Anzugsmomente sind ausschließlich empfohlen für eine Befestigung auf eine ebene, glatte Kletterfläche. Bei diesen Anzugsdrehmomenten wird verhindert dass sich der Griff dreht oder bricht.

Größen XS, S und M 25 Nm

Größen L, XL, Mega und Giga 30 Nm

Alle Hohlformen müssen mindestens an 2 Punkten befestigt werden!

Bei der Griffmontage auf unebene Oberflächen kann es zu Spannungsspitzen im Griff und in Folge zu einem Griffbruch kommen. In solchen Fällen erlischt der Garantieanspruch und es wird seitens des Herstellers keine Haftung übernommen.

Verbindungsmittel

Unsere Griffe können sowohl mit Zylinderkopfs als auch mit Senkkopfschrauben M10 befestigt werden.

Bohrlöcher - Warnung

Die Bohrungen sind nicht als Fingerloch beim Klettern gedacht. Verwenden sie das Bohrloch niemals zum Klettern, das kann schwerwiegende Fingerverletzungen verursachen.

Vor dynamischen Zügen prüfen sie, ob der gesetzte Griff dieser Belastung auch standhält und sich nicht verdreht!

SPS - (shatter protection system) Geprüfte Sicherheit

Für uns steht die Sicherheit der Menschen im Mittelpunkt. Unsere Griffe gibt es ab Größe L

nur mit SPS Hierbei wird ein Metallgitter als Bewehrung mit eingegossen. Die Gefahr durch herabfallende Griffteile wird so nahezu ausgeschlossen.

Optional ist auch eine Glasfaserbewehrung des gesamten Griffvolumens verfügbar.

Bei fachgerechter Montage unserer Griffe (richtiges Anzugsmoment, glatte, ebene Fläche) ist im Normalfall kein Griffbruch zu erwarten ist! Alle exzentrisch belastbaren Griffe weisen zusätzlich zur Befestigungsbohrung mindestens eine weitere 5 mm Bohrung zur Befestigung auf. Diese Befestigungsmöglichkeit muss verwendet werden um ein Verdrehen des Griffes zu verhindern.

Hohlformen

Großvolumige Griffe (ab Größe XXL) werden hohl produziert. Dadurch wird, bei gleicher Belastbarkeit, gleichermaßen Material und Gewicht eingespart. Das Anbringen der Hohlgriffe ist an mindestens 2 Punkten (große Bohrung plus mindestens eine Zusatzbefestigung) vorzusehen!

Werkzeug

Wir empfehlen die Verwendung von Drehmomentschlüsseln. Nur so kann sichergestellt werden, dass die vorgegebenen Anzugsmomente nicht überschritten werden.

Der Gebrauch von Schlagbohrern ist nicht zulässig. Die beim Schrauben dabei auftretenden Vibrationen werden auf den Griff übertragen und können zu einem Bruch (auch zu einem späteren Zeitpunkt) führen. Wenn nachweislich kein Drehmomentschlüssel verwendet wird unsererseits keine Haftung übernommen!

Farben

Die Farben unserer Griffe basieren auf dem RAL Standard und sind zu 100% UV beständig, womit sie sich auch bestens für den Einsatz outdoor eignen.

Oberflächen

Die Oberflächen weisen eine hautschonende Körnung auf. Auf eine raue und selektive Haltemöglichkeit wird jedoch bei jedem Griff geachtet.

Durch das „Chalken“ von Griffen vor dem Klettern können sich die Oberflächen z.T. schonender bzw. auch griffiger anfühlen.

Reinigung

Zur Reinigung empfehlen wir die Verwendung eines Hochdruckreinigers oder den Einsatz gängiger Griffreinigungsmittel. Dabei sind die von den Herstellern vorgegeben Konzentrationen und Einwirkzeiten einzuhalten.

Wartung/Kontrolle

Angeschraubte Griffe können mit der Zeit locker werden (Gebrauch, Temperaturunterschied, Vibration, ...). Prüfen Sie zur Erhöhung der Sicherheit beim Klettern in regelmäßigen Abständen, ob die Griffe noch fest sind und ziehen sie die Schrauben gegebenenfalls nach.

Fall / Bruch

Durch einen unkontrollierten Fall auch schon aus geringer Höhe auf harte Unterlage (z.B. bei der Montage) können unsichtbare Haarrisse im Griff auftreten, die in Folge bei der Befestigen zum Bruch führen können. Teile des Griffs können ausbrechen, wodurch scharfe Kanten entstehen, die zu gefährlichen Verletzungen führen können. Behandeln sie zur ihrer eigenen Sicherheit Griffe stets mit Sorgfalt und prüfen sie die Griffe auf Risse und Bruchstellen vor allem bei wiederholtem Anbringen.

Wir empfehlen aus Sicherheitsgründen, Griffe die bereits einmal gefallen sind, nicht mehr einzusetzen. Sollte ein Riss sichtbar sein, darf der Griff nicht mehr verwendet werden!

Gewährleistung

holycholds (DCD BauplanungsgesmbH) gewährt auf alle Griffe eine Garantie von 2 Jahren. Eventuell durch den Transport entstandene Schäden sind innerhalb von 1 Tag ab Erhalt der Ware per Email oder telefonisch zu reklamieren: Wir behalten uns das Recht vor, für den kostenlosen Austausch eindeutige Belegfotos anzufordern.



Design Construct Develop

climbing area



*Kletterwände
nach Maß.*

Design Construct Develop

holyholds



*Klettergriffe
inspiriert von der Natur,
interpretiert durch
modernste Technik.*



Design Construct Develop

engineering area



*Bauplanung
nach Maß.*

Bestellung



a product of



**ORDER
WEBSHOP**

**shop@holyholds.at
www.holyholds.at**

**STORE
PHONE**

**3340 Waidhofen/Ybbs Plenkerstraße 37
+43 (0)676 847166210**

Preise zuzüglich 20% USt. Verpackung & Versand

Shoppingspaß nach Maß.

OUTDOOR EQUIPMENT

ENTWICKELN BERATEN PLANEN BAUEN BEGLEITEN



www.holyholds.at
shop@holyholds.at

